

LAGAN



Design and Quality
IKEA of Sweden



ENGLISH

Please refer to the last page of this manual for the full list of IKEA appointed After Sales Service Provider and relative national phone numbers.

The electronic user manual is available at www.ikea.com.

中文

请参阅本手册最后一页，以获取宜家指定的售后服务提供商的完整列表以及相关国家的电话号码。

电子用户手册可在 www.ikea.com 上获取。

ENGLISH
中文

5
19

TABLE OF CONTENTS

Safety information.....	5	Specifications.....	15
Product description	9	Installation and connection.....	16
Control panel.....	10	Environmental concerns	16
Using the microwave oven	11	Ikea guarantee	17
Trouble shooting.....	15		

Safety information

⚠ WARNING! PRECAUTIONS TO AVOID POSSIBLE EXPOSURE TO EXCESSIVE MICROWAVE ENERGY

For your safety

- Do not attempt to operate this oven with the door open since this can result in harmful exposure to microwave energy. It is important not to break or tamper with the safety interlocks.
- Do not place any object between the oven front face and the door or allow soil or cleaner residue to accumulate on sealing surfaces.

- ⚠ **WARNING!** If the door or door seals are damaged, the oven must not be operated until it has been repaired by a qualified technician.

IMPORTANT SAFETY INSTRUCTIONS

WARNING

To reduce the risk of fire, electric shock, injury to persons or exposure to excessive microwave oven energy when using your appliance, follow basic precautions, including the following:

- Read and follow the specific: **"PRECAUTIONS TO AVOID POSSIBLE EXPOSURE TO EXCESSIVE MICROWAVE ENERGY"**.
- This device can be used by children aged 8 and older, and by individuals with reduced physical, sensory, or mental capabilities, or those lacking experience or knowledge, provided they are given proper instructions on the safe use of the device and understand the associated risks.

- Keep the appliance and its cord out of reach of children less than 8 years.
- If the supply cord is damaged, it must be replaced by the manufacturer, its service agent or similarly qualified persons in order to avoid a hazard.

- ⚠ **WARNING:** It is hazardous for anyone other than a competent person to carry out any service or repair operation that involves the removal of a cover which gives protection against exposure to microwave energy.
- When heating food in plastic or paper containers, keep an eye on the oven due to the possibility of ignition.
- Only use utensils that are suitable for use in microwave ovens.
- If smoke is emitted, switch off or unplug the appliance and keep the door closed in order to stifle any flames.
- Microwave heating of beverages can result in delayed eruptive boiling, therefore care must be taken when handling the container.
- The contents of feeding bottles and baby food jars shall be stirred or shaken and the temperature checked before consumption, in order to avoid burns.
- Eggs in their shell and whole hard-boiled eggs should not be heated in microwave ovens since they may explode, even after microwave heating has ended.
- The oven should be cleaned regularly and any food deposits removed.
- Failure to maintain the oven in a clean condition could lead to deterioration of the surface that could adversely affect the

life of the appliance and possibly result in a hazardous situation.

- The appliance must not be installed behind a decorative door in order to avoid overheating.
- Only use the temperature probe recommended for this oven. (For ovens provided with a facility to use a temperature-sensing probe.)
- The microwave oven must be operated with the decorative door open. (For ovens with a decorative door.)
- This appliance is intended to be used in household and similar applications such as:
 - staff kitchen areas in shops, offices and other working environments;
 - by clients in hotels, motels and other residential type environments;
 - farm houses;
 - bed and breakfast type environments.
- The microwave oven is intended for heating food and beverages. Drying of food or clothing and heating of warming pads, slippers, sponges, damp cloth and similar may lead to risk of injury, ignition or fire. Metallic containers for food and beverages must not be used as they may ignite.
- The appliance shall not be cleaned with a steam cleaner.
- The microwave oven is intended to be used built-in.
- The rear surface of appliances shall be placed against a wall.
- The appliances are not intended to be operated by means of an external timer or separate remote-control system.
- The temperature of accessible surfaces may be high when the appliance is operating.

⚠ WARNING: When the appliance is operated in the combination mode, children should only use the oven under adult supervision due to the temperatures generated.

⚠ WARNING: To prevent burns, please do not touch the microwave while it is running.

SAVE THESE INSTRUCTIONS

READ CAREFULLY AND KEEP FOR FUTURE REFERENCE.

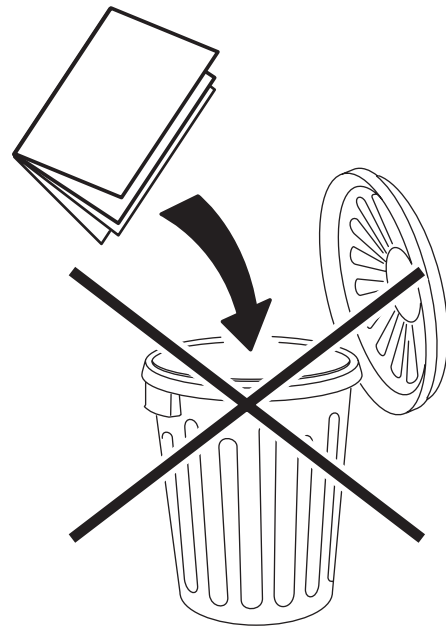

TO REDUCE THE RISK OF INJURY TO PERSONS GROUNDING INSTALLATION

⚠ DANGER

Electric Shock Hazard

Touching some of the internal components can cause serious personal injury or death. Do not disassemble this appliance.

⚠ WARNING!

Electric Shock Hazard

Improper use of the grounding can result in electric shock. Do not plug into an outlet until appliance is properly installed and grounded.

This appliance must be grounded. In the event of an electrical short circuit, grounding reduces the risk of electric shock by providing an escape wire for the electric current. This appliance is equipped with a cord having a grounding wire with a grounding plug. The plug must be plugged into an outlet that is properly installed and grounded.

Consult a qualified electrician or serviceman if the grounding instructions are not completely understood or if doubt exists as to whether the appliance is properly grounded. If it is necessary to use an extension cord, use only a 3-wire extension cord.

- A short power-supply cord is provided to reduce the risks resulting from becoming entangled in or tripping over a longer cord.
- If a long cord set or extension cord is used:
 - The marked electrical rating of the cord set or extension cord should be at least as great as the electrical rating of the appliance.
 - The extension cord must be a grounding-type 3-wire cord.
 - The long cord should be arranged so that it will not drape over the counter top or tabletop where it can be pulled on by children or tripped over unintentionally.

CLEANING

Be sure to unplug the appliance from the power supply.

- Clean the cavity of the oven after using with a slightly damp cloth.
- Clean the accessories in the usual way in soapy water.
- The door frame and seal and neighbouring parts must be cleaned carefully with a damp cloth when they are dirty.
- Do not use harsh abrasive cleaners or sharp metal scrapers to clean the oven door glass since they can scratch the surface, which may result in shattering of the glass.
- Cleaning Tip ★ For easier cleaning of the cavity walls that the food cooked can touch: Place half a lemon in a bowl, add 300ml (1/2 pint) water and heat on 100% microwave power for 10 minutes. Wipe the oven clean using a soft, dry cloth.

⚠ CAUTION

Personal Injury Hazard

It is hazardous for anyone other than a competent person to carry out any service or repair operation that involves the removal of a cover which gives protection against exposure to microwave energy.

See the instructions on **“MATERIALS YOU CAN USE IN MICROWAVE OVEN OR TO BE AVOIDED IN MICROWAVE OVEN.”**

There may be certain non-metallic utensils that are not safe to use for microwaving. If in doubt, you can test the utensil in question following the procedure below.

Utensil Test:

- Fill a microwave-safe container with 1 cup of cold water (250ml) along with the utensil in question.
- Cook on maximum power for 1 minute.
- Carefully feel the utensil. If the empty utensil is warm, do not use it for microwave cooking.
- Do not exceed 1 minute cooking time.

Materials you can use in microwave oven

Utensils	Remarks
Browning dish	Follow manufacturer's instructions. The bottom of browning dish must be at least 3/16 inch (5 mm) above the turntable. Incorrect usage may cause the turntable to break.
Dinnerware	Microwave-safe only. Follow manufacturer's instructions. Do not use cracked or chipped dishes.
Glass jars	Always remove lid. Use only to heat food until just warm. Most glass jars are not heat resistant and may break.
Glassware	Heat-resistant oven glassware only. Make sure there is no metallic trim. Do not use cracked or chipped dishes.
Oven cooking bags	Follow manufacturer's instructions. Do not close with metal tie. Make slits to allow steam to escape.
Paper plates and cups	Use for short-term cooking/warming only. Do not leave oven unattended while cooking.
Paper towels	Use to cover food for reheating and absorbing fat. Use with supervision for a short-term cooking only.
Parchment paper	Use as a cover to prevent splattering or a wrap for steaming.
Plastic	Microwave-safe only. Follow the manufacturer's instructions. Should be labeled "Microwave Safe". Some plastic containers soften, as the food inside gets hot. "Boiling bags" and tightly closed plastic bags should be slit, pierced or vented as directed by package.
Plastic wrap	Microwave-safe only. Use to cover food during cooking to retain moisture. Do not allow plastic wrap to touch food.
Thermometers	Thermometers Microwave-safe only (meat and candy thermometers).
Wax paper	Use as a cover to prevent splattering and retain moisture.

Materials to be avoided in microwave oven

Utensils	Remarks
Aluminum tray	May cause arcing. Transfer food into microwave-safe dish.
Food carton with metal handle	May cause arcing. Transfer food into microwave-safe dish.
Metal or metaltrimmed utensils	Metal shields the food from microwave energy. Metal trim may cause arcing.
Metal twist ties	May cause arcing and could cause a fire in the oven.
Paper bags	May cause a fire in the oven.
Plastic foam	Plastic foam may melt or contaminate the liquid inside when exposed
Wood	Wood will dry out when used in the microwave oven and may split or crack.

Product description

Setting up your oven

Name of oven parts and accessories

Remove the oven and all materials from the carton and oven cavity. Your oven comes with the following accessories:

Glass tray	1x
Turntable ring assembly	1x
Instruction manual	1x
Drilling template	1x
Assembly instruction	1x

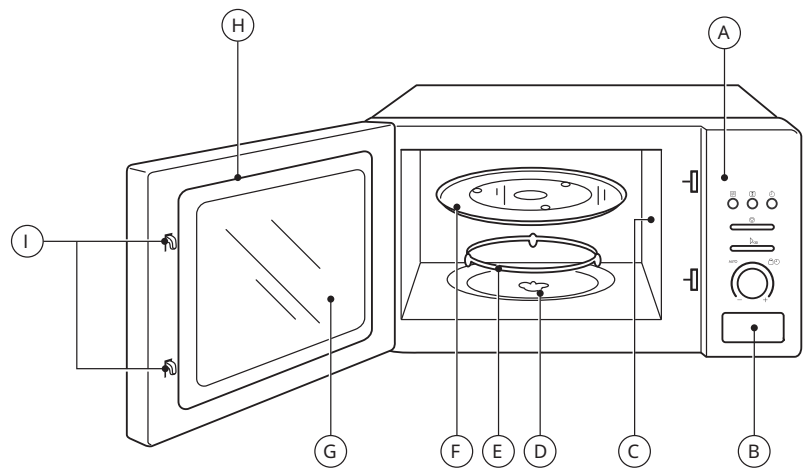

- A) Control panel
- B) Door opening button
- C) Wave guide cover (Do not remove)
- D) Turntable shaft
- E) Turntable ring assembly
- F) Glass tray
- G) Observation window
- H) Door assembly
- I) Safety interlock system

Turntable installation

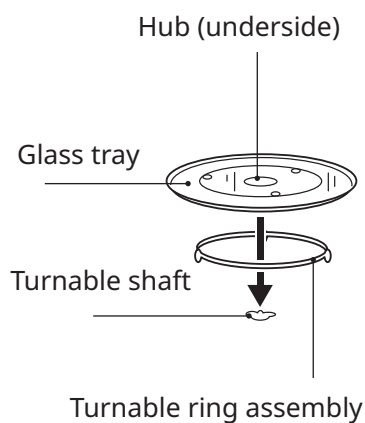





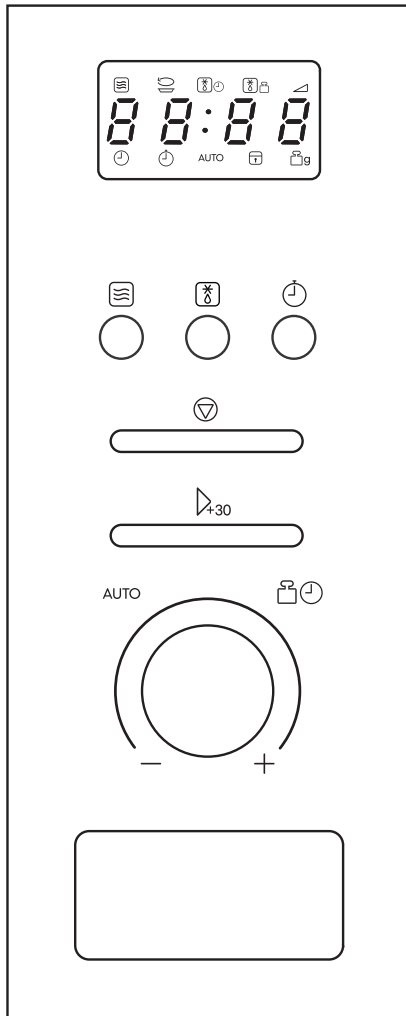

- a) Never place the glass tray upside down. The glass tray should never be restricted.
- b) Both glass tray and turntable ring assembly must always be used during cooking.
- c) All food and containers of food are always placed on the glass tray for cooking.
- d) If glass tray or turntable ring assembly cracks or breaks, contact your nearest authorized service center.
- e) Never put frozen food directly on a warm turntable.

Control panel



INSTRUCTION

-  Microwave
-  Kitchen timer/Clock
-  Start/+30 Sec/Confirm
-  Time
-  Weight/Time Defrost
-  Stop/Clear
- AUTO Auto Menu

Using the microwave oven

Using the knob

To use the selection knob, push it inwards and it will pop out.

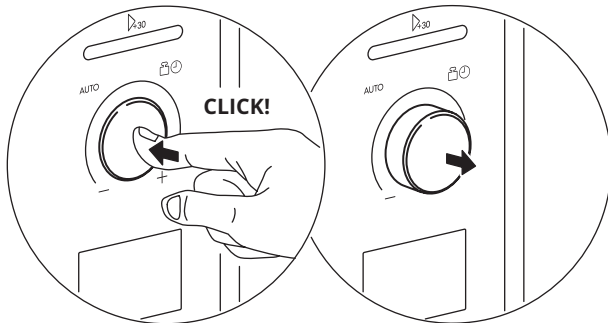

Open the door

Push the button to open the door.

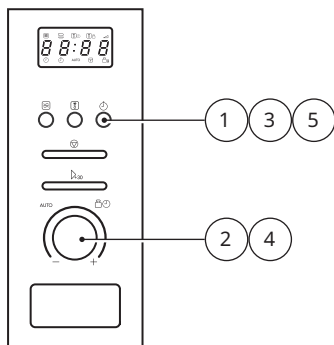
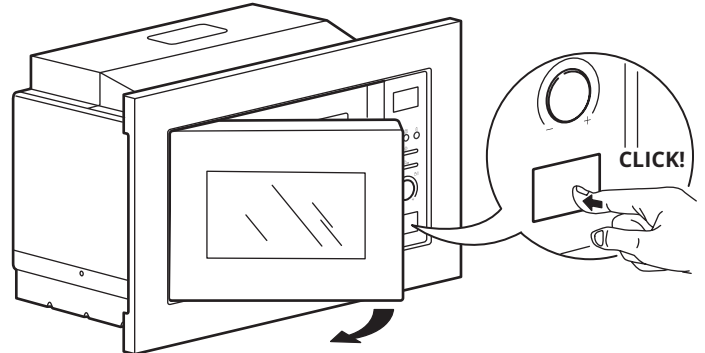

Clock setting

When the microwave oven is electrified, the screen will display "0:00", buzzer will ring once.

1. Press **Kitchen timer/Clock** twice to select clock function, the hour figures will flash.
2. Turn knob to adjust the hour figures, the input time should be within 0--23.
3. Press **Kitchen timer/Clock**, the minute figures will flash, the hour figures will light.
4. Turn knob to adjust the minute figures, the input time should be within 0--59.
5. Press **Kitchen timer/Clock** to finish clock setting, : will flash.

Note: During the process of clock setting, if you do not press **Kitchen timer/Clock** to confirm in 1 minute, the oven will go back to previous status automatically.

Lock-out function for children

Lock: In waiting state, press **Stop/Clear** for 3 seconds, there will be a long "beep" denoting entering the children-lock state and screen will display [] or current time.

Lock quitting: In locked state, press **Stop/Clear** for 3 seconds, there will be a long "beep" denoting that the lock is released.

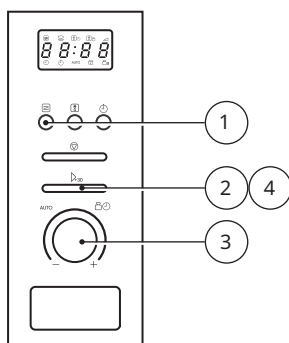

Microwave cooking

1. Press **Microwave** once, the screen will display **80** flickering. Press **Microwave** repeatedly or turn the knob to choose the power you want.
2. Then press **Start/+30 Sec** to confirm selected power level.
3. Turn knob to set cooking time from 0:05 to 95:00.
4. Press **Start/+30 Sec** again to start cooking.

Note: The time steps for the time when turning the knob are as follow:

0---1 min	: 5 seconds
1--- 5min	: 10 seconds
5---10 min	: 30 seconds
10---30 min	: 1 minute
30---95 min	: 5 minutes

Quick start alternative 1

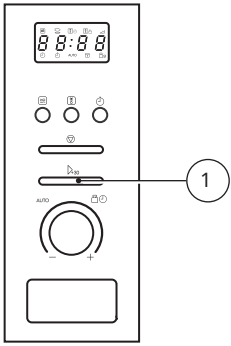

Quick start alternative 2

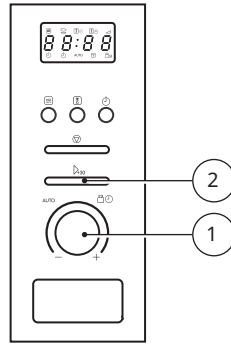

Quick start alternative 1

1. In stand by mode, press Δ_{+30} **Start/+30 Sec** to start cooking with full power for 30 seconds, each added press will increase 30 seconds cooking time up to 95 minutes.

Quick start alternative 2

1. In stand by mode, turn the knob \odot to the right to set the time.
2. Press Δ_{+30} **Start/+30 Sec** to start cooking at full microwave power.

Note: In microwave or time defrost state, each press of Δ_{+30} **Start/+30 Sec** can increase 30 seconds of cooking time.

Defrost by weight

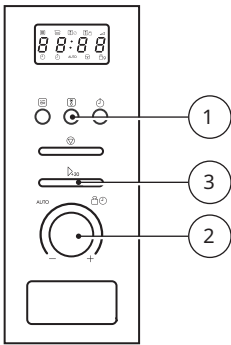

Defrost by time

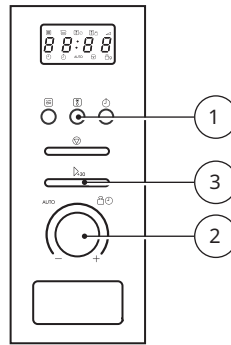

Defrost by weight

1. Press $\text{[Weight/Time Defrost]}$ **Weight/Time Defrost** once, and the oven will display **def1**.
2. Turn the knob \odot to select the weight of food from 100 to 2000g.
3. Press Δ_{+30} **Start/+30 Sec** to start defrosting.

Defrost by time

1. Press $\text{[Weight/Time Defrost]}$ **Weight/Time Defrost** twice, and the oven will display **def2**.
2. Turn the knob \odot to select the defrost time. The MAX. time is 95 minutes.
3. Press Δ_{+30} **Start/+30 Sec** to start defrosting.

The product will prompt you to turn the food after half of the time set for defrosting. Open the door and turn the food, shut the door and press Δ_{+30} **Start/+30 Sec** to continue the defrosting.

Kitchen timer

1. Press $\text{[Kitchen timer/Clock]}$ **Kitchen timer/Clock** once, screen will display **00:00**, clock indicator will light.
2. Turn the knob \odot to enter the correct time. (Maximum time to set is 95 minutes.)
3. Press Δ_{+30} **Start/+30 Sec** to confirm setting, clock indicator will be flickering.

When the kitchen time is reached, clock indicator will go out and the buzzer will ring 5 times.

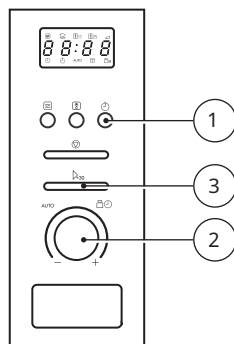

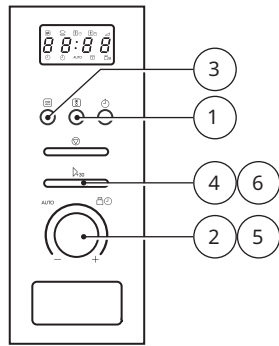

The product can be set to perform a multi stage cooking, defrosting followed by reheating:

Multi-section cooking

1. Press **Weight/Time Defrost** twice, and the oven will display **dEF2**.
2. Turn the knob to select the defrost time.
3. Press **Microwave** once, the screen will display **80**, repeatedly push the button or turn the knob to set the requested microwave power.
4. Press **Start/+30 Sec** to confirm power setting.
5. Turn the knob to select cooking time.
6. Press **Start/+30 Sec** to start cooking.

The product will prompt you to turn the food after half of the time set for defrosting. Open the door and turn the food, shut the door and press **Start/+30 Sec** to continue the defrosting. The buzzer will sound once again entering the second cooking. When cooking finishes, buzzer sound five times.

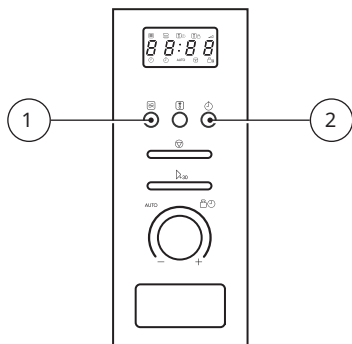

Inquiring function

1. In state of microwave cooking, press **Microwave**, the current power will be displayed for 3 seconds.
2. In cooking state, press **Kitchen timer/Clock** to inquire the time of the day, the time will be displayed for 3 seconds.

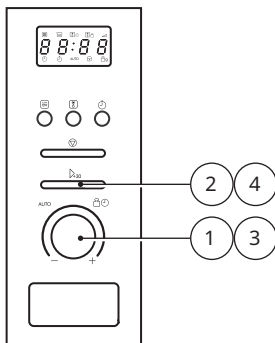

Auto menu

1. Turn the knob "A" left to choose the menu, and **A-1 to A-8** will display.
2. Press **Start/+30 Sec** to confirm selected food.
3. Turn the knob "A" to choose the default weight as the menu chart.
4. Press **Start/+30 Sec** to start cooking.

MENU	WEIGHT	DISPLAY
A-1 Pizza	200g	200
	400g	400
A-2 Meat	250g	250
	350g	350
	450g	450
A-3 Vegetable	200g	200
	300g	300
	400g	400
A-4 Pasta	50g (with 450g cold water)	50
	100g (with 800g cold water)	100
A-5 Potato	200g	200
	400g	400
	600g	600
A-6 Fish	250g	250
	350g	350
	450g	450
A-7 Beverage	1 cup (120ml)	1
	2 cups (240ml)	2
	3 cups (360ml)	3
A-8 Popcorn	50g	50
	100g	100

Note: The Foodclasses can also be found on the label inside the door.

Trouble shooting

Normal	
Microwave oven interfering TV reception	Radio and TV reception may be interfered when microwave oven operating. It is similar to the interference of small electrical appliances, like mixer, vacuum cleaner, electric fan. It is normal.
Dim oven light	In low power microwave cooking, oven light may become dim. It is normal.
Steam accumulating on door, hot air out of vents.	In cooking, steam may come out of food. Most will get out from vents, but some may accumulate on cool place like oven door. It is normal.
Oven started accidentally with no food in.	<i>It is forbidden to run the unit without any food inside. It is very dangerous.</i>

Trouble	Possible cause	Remedy
Oven can not be started.	(1) Power cord not plugged tightly.	Unplug the cord. Wait 10 seconds and plug it again.
	(2) Fuse blowing or circuit breaker works.	Replace fuse or reset circuit breaker (repaired by professional personnel of our company)
	(3) Trouble with outlet.	Test outlet with other electrical appliances.
Oven does not heat	(4) Door not closed well.	Close door well.

Specifications

Model:	LAGAN 706.094.95
Rated Voltage:	220V~50 Hz
Rated Input Power (Microwave):	1250 W
Rated Output Power (Microwave):	800 W
Oven Capacity:	20 L
Turnable Diameter:	Ø 245 mm
External Dimensions:	595x344x394 mm
Net Weight:	15 kg
Noise level:	≤ 63dB (A)

Serial Number (start with SN, 22-digit code)

Serial number:xxxxxxxxxxxxxxxxxxxxxx

Article Number (8-digit code)

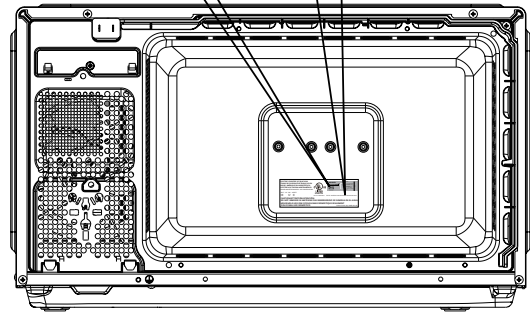

Picture for reference only

Installation and connection

1. This appliance is only intended for domestic use.
2. This oven is intended for built-in use only. It is not intended for counter-top use or for use inside a cupboard.
3. Please observe the special installation instructions.
4. The appliance can be installed in a 60cm wide wall-mounted cupboard.
5. The appliance is fitted with a plug and must only be connected to a properly installed earthed socket.
6. The mains voltage must correspond to the voltage specified on the rating plate.
7. The socket must be installed and connecting cable must only be replaced by a qualified electrician. If the plug is no longer accessible following

installation, an all-pole disconnecting device must be present on the installation side with a contact gap of at least 3mm.

8. Adapters, multi-way strips and extension leads must not be used. Overloading can result in a risk of fire.
9. The product should not be mounted below 85cm.



The accessible surface maybe hot during operation.

Environmental concerns



According to Waste of Electrical and Electronic Equipment (WEEE) directive, WEEE should be separately collected and treated. If at any time in future you need to dispose of this product please do not dispose of this product with household waste. Please send this product to WEEE collecting points where available.

Ikea guarantee

How long is the IKEA guarantee valid?

This guarantee is valid for five (5) years from the original date of purchase of your appliance at IKEA. The original sales receipt is required as proof of purchase. If service work is carried out under guarantee, it will not extend the guarantee period for the appliance.

Which LAGAN appliances are not covered by the IKEA 5-year guarantee?

LAGAN appliances purchased from IKEA before 1 May 2026 are covered by a 2-year guarantee, starting from the original date of purchase.

Who will execute the service?

Contact nearest IKEA store.

What does this guarantee cover?

The guarantee covers faults of the appliance, which have been caused by faulty construction or material faults from the date of purchase from IKEA. This guarantee applies to domestic use only. The exceptions are specified under the headline "What is not covered under this guarantee?" Within the guarantee period, the costs to remedy the fault e.g. repairs, parts, labour and travel will be covered, provided that the appliance is accessible for repair without special expenditure. Replaced parts become the property of IKEA.

What will IKEA do to correct the problem?

IKEA will examine the product and decide, at its sole discretion, if it is covered under this guarantee. If considered covered, IKEA will then, at its sole discretion, either repair the defective product or replace it with the same or a comparable product.

What is not covered under this guarantee?

- Normal wear and tear.
- Deliberate or negligent damage, damage caused by failure to observe operating instructions, incorrect installation or by connection to the wrong voltage, damage caused by chemical or electrochemical reaction, rust, corrosion or water damage including but not limited to damage caused by excessive lime in the water supply, damage caused by abnormal environmental conditions.
- Consumable parts including batteries and lamps.
- Non-functional and decorative parts which do not affect normal use of the appliance, including any scratches and possible colour differences.
- Accidental damage caused by foreign objects or substances and cleaning or unblocking of filters, drainage systems or soap drawers.
- Damage to the following parts: ceramic glass, accessories, crockery and cutlery baskets, feed and drainage pipes, seals, lamps and lamp covers, screens, knobs, casings and parts of casings. Unless such damages can be proved to have been caused by production faults.
- Repairs not carried out by our appointed service providers and/or an authorized service contractual partner or where non-original parts have been used.
- Repairs caused by installation which is faulty or not according to specification.
- The use of the appliance in a non-domestic environment i.e. professional use.
- Transportation damages. If a customer transports the product to his home or another address, IKEA is not liable for any damage that may occur during transport. However, if IKEA delivers the product to the customer's delivery address, then damage to the product that occurs during this delivery will be covered by IKEA.
- Cost for carrying out the initial installation of the IKEA appliance. However, if an IKEA appointed Service Provider or its authorized service partner repairs or replaces the appliance under the terms of this guarantee, the appointed Service Provider or its authorized service partner will reinstall the repaired appliance or install the replacement, if necessary.

How country law applies

The IKEA guarantee gives you specific legal rights, which cover or exceed all the local legal demands. However these conditions do not limit in any way consumer rights described in the local

Area of validity

For appliances which are purchased in one EU country and taken to another EU country, the services will be provided in the framework of the guarantee conditions normal in the new country. An obligation to carry out services in the framework of the guarantee exists only if the appliance complies and is installed in accordance with:

- the technical specifications of the country in which the guarantee claim is made;
- the Assembly Instructions and User Manual Safety Information.

AFTER SALES for IKEA appliances

Please don't hesitate to contact IKEA to:

- make a service request under this guarantee.
- ask for clarification on functions of IKEA appliances.

To ensure that we provide you with the best assistance, please read carefully the Assembly Instructions and/or the User Manual before contacting us.

How to reach us if you need our service



Service Hotline Number: 400-8002-345
Hotline Service Period: 9:00-21:00

The IKEA after sales customer service centre will assist you on the phone with basic trouble shooting for your appliance at the time of service call request. Please see the IKEA catalogue or visit www.ikea.com to find your local store phone number and opening time.

In order to provide you a quicker service, please also always refer to the IKEA article number (8 digit code) placed on the rating plate of your appliance.

SAVE THE SALES RECEIPT!

It is your proof of purchase and required for the guarantee to apply. The sales receipt also reports the IKEA name and article number (8 digit code) for each of the appliances you have purchased.

Do you need extra help?

For any additional questions not related to After Sales of your appliances please contact your nearest IKEA store call centre. We recommend you read the appliance documentation carefully before contacting us.

目录

安全信息.....	19	规格.....	28
产品描述.....	22	安装和连接.....	28
控制面板.....	23	环保要求.....	28
使用微波炉.....	24	宜家质保.....	29
故障排除.....	27		

安全信息

⚠ 警告！ 为避免可能接触到过量的微波能量而采取的预防措施

安全注意事项

- 请勿尝试在门打开状态下操作此微波炉，否则可能导致接触有害的微波能量。切勿损坏或篡改安全联锁装置。
- 请勿在微波炉前端和舱门间放置任何物体，或允许污垢或清洁剂残留物在密封表面积聚。

⚠ **警告！** 如果舱门或舱门密封圈损坏，在专业技术人员修复之前，必须停止使用微波炉。

重要安全说明

警告

为降低使用本微波炉时发生火灾、触电、人身伤害或接触过量微波炉能量的风险，请遵循以下基本预防措施：

- 请阅读并遵循以下具体内容：“**为避免可能接触到过量的微波能量而采取的预防措施**”。
- 如接受过安全使用方面的正确指导且知晓相关安全风险，本电器可由年满 8 岁的儿童，身体、感官或智力方面存在缺陷的人士，或者缺乏相关经验或知识的人士使用。
- 请将本电器及其电源线置于 8 岁以下儿童无法触及的位置。
- 如果电源软线损坏，为防危险，应由制造商、其维修部门或类似部门的专业人员更换。

⚠ **警告：** 顶盖可防止接触微波能量，因此必须由专业人员执行需要拆除顶盖的服务或维修操作，以防发生危险。

- 在塑料或纸质容器中加热食物时，请留意微波炉内是否出现着火。
- 仅允许使用适于在微波炉中使用的器具。

- 如果产生烟雾，请关闭或拔下电器插头并保持舱门紧闭以熄灭明火。
- 用微波加热饮料可能会导致延迟的喷发沸腾，因此在处理容器时须格外小心。
- 加热后，应对奶瓶和婴儿食品罐内的食物进行搅拌或摇动并在食用前查验温度，以免发生烫伤。
- 带壳鸡蛋以及煮熟的鸡蛋不可在微波炉中加热，否则即便微波加热结束后，也可能发生爆炸。
- 应定期清洁微波炉，并清除所有食物沉积物。
- 若未能保持微波炉处于清洁状态，则可能会导致表面老化，从而影响电器的使用寿命，且有可能导致危险情况。
- 本电器不得安装在装饰门后，以免出现过热。
- 仅可使用推荐微波炉使用的温度探头。（针对配备了温度传感探头使用设施的微波炉。）
- 操作微波炉时必须保持装饰门打开。（针对带装饰门的微波炉。）
- 本电器适用于家庭及以下类似场景：
 - 商店、办公室和其他工作环境内的员工厨房区域；
 - 酒店、汽车旅馆、简易旅馆，以及其他居住环境；
 - 农舍；
 - B&B（住宿加早餐）类型的环境。
- 微波炉可用于加热食物和饮料。对食物或衣物进行烘干以及对加热垫、拖鞋、海绵、湿布等物体进行加热可能会引发受伤、着火或起火风险。禁止使用金属食品饮料容器，否则可能着火。
- 不得用蒸汽清洁器清洁本电器。
- 本微波炉设计内置使用。
- 本电器后表面应靠墙放置。
- 请勿使用外部定时器或单独的遥控系统操作本电器。

- 本电器运行时可接触表面的温度可能较高。

△ **警告：** 本电器在混合加热模式下运行时，由于存在高温，除非有成人监视，否则不可由儿童使用。

△ **警告：** 为避免烫伤，微波炉正在运行时请勿接触。

请妥善保管本手册

请仔细阅读并妥善保存，以备将来参考。

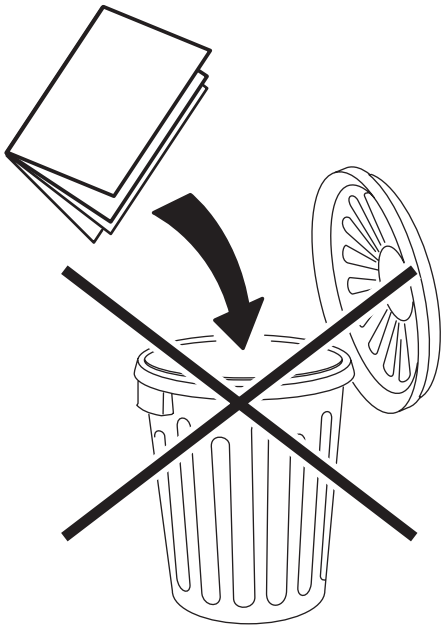

降低接地安装人员的受伤风险

△ 危险

触电危险

接触某些内部组件可能会导致严重人身伤害，甚至死亡。请勿拆卸本电器。

△ 警告！

触电危险

接地不当可能会导致触电。在正确安装本电器并对其进行接地之前，请勿插入电源插座。

本电器必须接地。在发生电气短路的情况下，接地能为电流提供引流线，从而降低触电风险。本电器配有带接地线和接地插头的电源线。必须将插头插入安装正确且已接地的插座。

如果未完全理解接地说明或不确定电器是否已正确接地，请咨询合格的电工或维修人员。如有必要使用延长线，请仅使用 3 芯延长线。

- 我们所提供的电源线较短，以便降低因被较长的电线缠绕或绊倒而引发的风险。
- 如果使用长电源线或延长线：
 - 电源线或延长线的电气额定值应至少与本电器的电气额定值相同。
 - 延长线必须为接地型 3 芯电源线。
 - 对长电源线进行布线时，应确保其未搭在柜台顶部或桌面，以免儿童对其进行拉扯或不慎被绊倒。

清洗

务必拔出该电器的电源插头。

- 使用略湿的清洁布，清洁使用后的微波炉腔体。
- 用肥皂水常规方式清洗配件。
- 当舱门框和密封圈及相邻部件变脏时，必须用湿布小心清洗。
- 请勿用粗糙的研磨清洁剂或锋利的金属刮刀来清洁微波炉舱门玻璃，以防划伤表面，导致玻璃破碎。
- 清洗提示 ★ 为方便清洗加热食物可能触及的微波炉内壁：将半个柠檬置于碗中，加入 300 毫升（1/2 品脱）的水，并用 100% 微波火力加热 10 分钟。用柔软的干布擦拭微波炉。

△ 注意

人身伤害危险

顶盖可防止接触微波能量，因此必须由专业人员执行需要拆除顶盖的服务或维修操作，以防发生危险。

请参阅有关“可在微波炉中使用或应避免在微波炉中使用的材料”的说明。

某些非金属器具可能不适于微波加热。如有疑问，您可以按照以下步骤测试所述器具。

器具测试：

- 在可安全进行微波加热的容器中倒入 1 杯冷水（250 毫升），并将可疑器具一放入。
- 以最大火力加热 1 分钟。
- 小心感受器具的温度。如果空器具变热，则不得将其用于微波加热。
- 加热时间请勿超过 1 分钟。

可在微波炉中使用的材料

器具	备注
加热盘	请遵循制造商的说明。加热盘底部必须至少高出转盘 5 毫米（3/16 英寸）。使用不当可能会导致转盘损坏。
餐具	仅限可安全进行微波加热的餐具。请遵循制造商的说明。请勿使用破裂或有缺口的餐盘。
玻璃罐	务必移除盖子。仅用于将食物加热至温热。多数玻璃罐不耐热，且可能会破裂。
玻璃器皿	仅限耐热的微波炉适用玻璃器皿。确保无金属饰边。请勿使用破裂或有缺口的餐盘。
微波烹饪袋	请遵循制造商的说明。请勿用金属夹将其密封。留出缝隙以便蒸汽逸出。
纸盘和纸杯	仅用于短时间加热。请勿在加热时离开微波炉。
纸巾	用于覆盖食物以重新加热和吸收脂肪。仅在有人监督的情况下用于短时间加热。
羊皮纸	用作盖子以防止飞溅或用作蒸烘包裹物。
塑料容器	仅限可安全进行微波加热的餐具。请遵循制造商的说明。应标注“微波安全”字样。随着内部食物变热，某些塑料容器会变软。“蒸煮袋”和密闭的塑料袋应按包装指示撕开、戳破或排气。
塑料包裹膜	仅限可安全进行微波加热的餐具。用于在加热期间覆盖食物以保持水分。请勿让塑料包裹膜接触食物。
温度计	仅限微波安全的温度计（肉类和糖果温度计）。
蜡纸	用作盖子以防止飞溅和保持水分。

避免在微波炉中使用的材料

器具	备注
铝制托盘	可能会导致电弧放电。将食物转移到可微波加热的盘中。
带金属柄的食物纸盒	可能会导致电弧放电。将食物转移到可微波加热的盘中。
金属或金属边饰的器具	金属可阻止食物进行微波受热。金属边饰可能会导致电弧放电。
金属捆扎带	可能会导致电弧放电，并有可能导致微波炉起火。
纸袋	可能会导致微波炉起火。
塑料泡沫	暴露于高温时，塑料泡沫可能会熔化或污染内部液体。
木材	在微波炉中使用时，木材会变干并有可能开裂或破裂。

产品描述

设置微波炉

微波炉零件和配件的名称

从纸箱和微波炉腔中取出微波炉及所有材料。
此微波炉随附以下配件：

玻璃托盘	1个
转盘环组件	1个
使用说明书	1个
钻模板	1个
装配说明书	1个

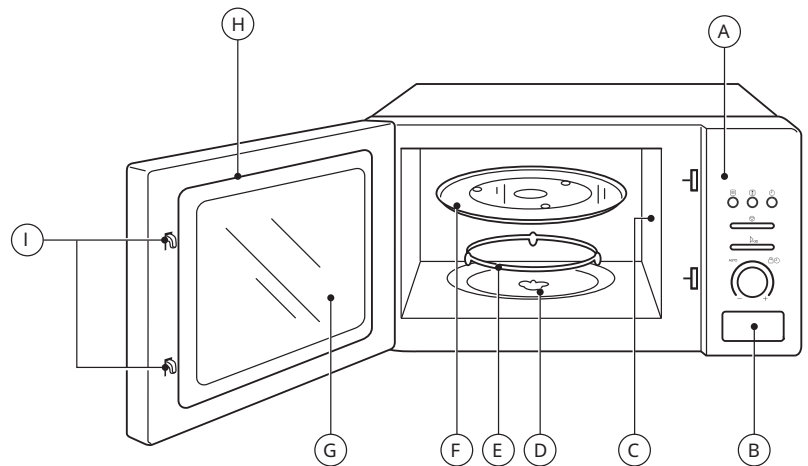

- A) 控制面板
- B) 开门按钮
- C) 波导罩 (请勿移除)
- D) 转盘轴
- E) 转盘环
- F) 玻璃托盘
- G) 观察窗
- H) 舱门组件
- I) 安全联锁系统

转盘安装

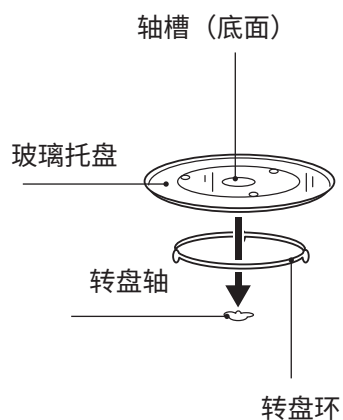





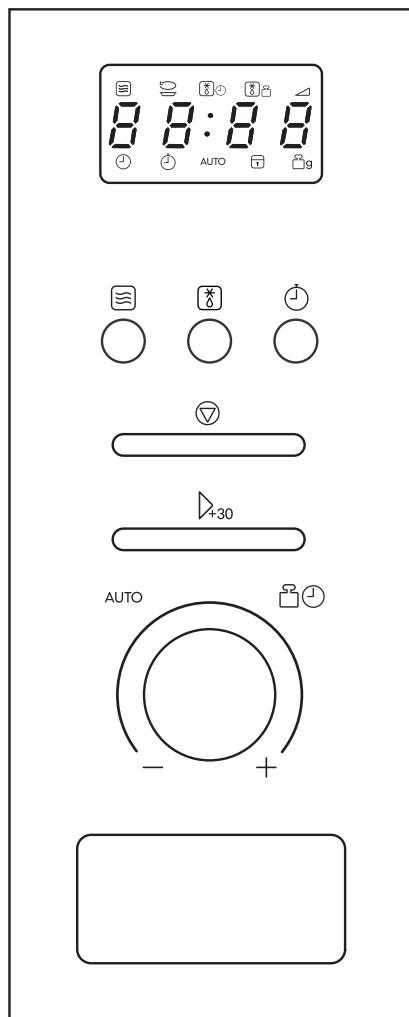

- a) 切勿将玻璃托盘倒置。切勿妨碍玻璃托盘转动。
- b) 加热期间始终须使用玻璃托盘和转盘环。
- c) 所有食物和食物容器均应始终放在玻璃托盘上进行加热。
- d) 如果玻璃托盘或转盘环出现破裂或断裂，请与最近的授权服务中心联系。
- e) 切勿将冷冻食品直接放在热的转盘上。

控制面板



说明

-  微波
-  厨房定时器/时钟
-  启动/+30 秒/确认
-  时间
-  按重量/时间解冻
-  停止/清除
- AUTO 自动菜单

使用微波炉

使用旋钮

要使用选择旋钮，请向内按压以将其弹出。

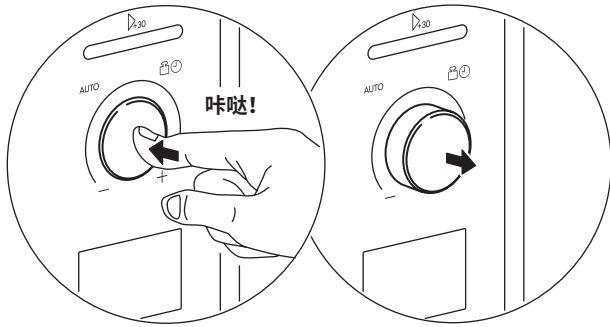

打开舱门

按下按钮以开启舱门。

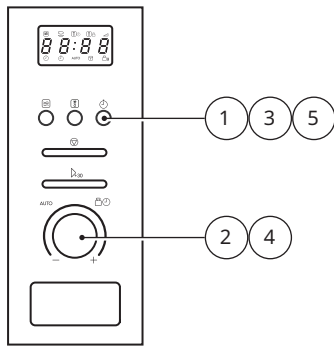
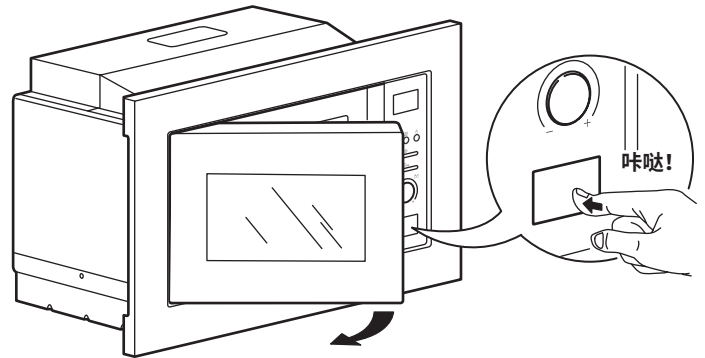

时钟设置

当微波炉通电时，屏幕会显示“0:00”，蜂鸣器也会发出一声蜂鸣。

1. 连按 厨房定时器/时钟两次可选择时钟功能，小时数字也会随之闪烁。
2. 转动旋钮 以调整小时数字，且输入的时间应介于 0-23 之间。
3. 按下 厨房定时器/时钟，分钟数字将随之闪烁，小时数字也会亮起。
4. 转动旋钮 以调整分钟数字，且输入的时间应介于 0-59 之间。
5. 按下 厨房定时器/时钟以完成时钟设置，: 会随之闪烁。

注意：时钟设置期间，如果未在 1 分钟内按下 厨房定时器/时钟进行确认，微波炉则会自动返回先前的状态。

童锁功能

锁定：在等待状态下，按住 停止/清除 3 秒钟，微波炉将发出长“哔”声以表示进入童锁状态，且屏幕显示 [] 或当前时间。

解锁：在锁定状态下，按住 停止/清除 3 秒钟，微波炉将发出长“哔”声以表示解除锁定。

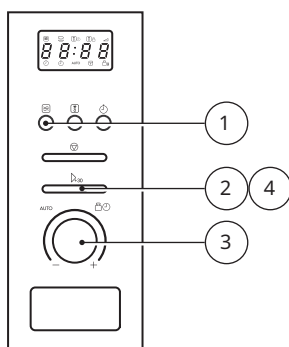

微波加热

1. 按下 微波一次，屏幕会显示闪烁的 80 字样。连续按下 微波进行选择，或转动旋钮以选择所需火力。
2. 然后，按下 启动/+30 秒以确认选定的火力。
3. 转动旋钮 ，设置 0:05 到 95:00 的加热时间。
4. 再次按下 启动/+30 秒，开始加热。

注意：转动旋钮时的时间步骤如下：

0-1 分钟	: 5 秒钟
1-5 分钟	: 10 秒
5-10分钟	: 30 秒
10-30分钟	: 1 分钟
30-95分钟	: 5 分钟

快速启动替代方案 1

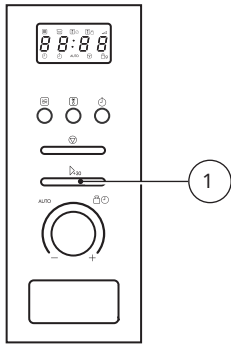

快速启动替代方案 2

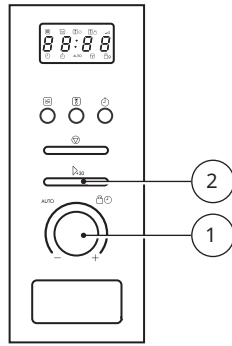

按重量解冻

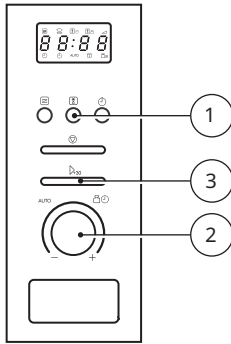

按时间解冻

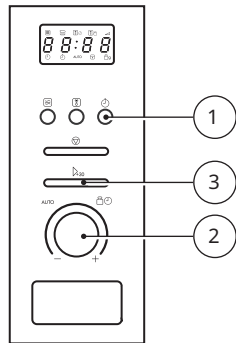
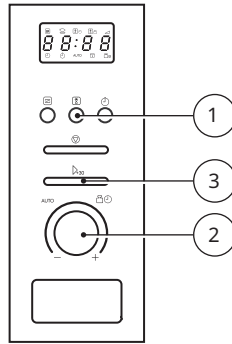

快速启动替代方案 1

1. 在待机模式下，按下 Δ_{30} 启动/+30 秒以全火力加热 30 秒，而每多按一次可延长 30 秒加热时间（最长为 95 分钟）。

快速启动替代方案 2

1. 在待机模式下，向右转动旋钮 \odot 以设置时间。
2. 按下 Δ_{30} 启动/+30 秒以全微波火力开始加热。

注意：在微波或定时解冻状态下，每按一次 Δ_{30} 启动/+30 秒可增加 30 秒加热时间。

按重量解冻

1. 按下 DEF 按重量/时间解冻一次，微波炉会显示 dEF1。
2. 转动旋钮 \odot 以选择介于 100 到 2000 克的食物重量。
3. 按下 Δ_{30} 启动/+30 秒以启动解冻。

按时间解冻

1. 连按 DEF 按重量/时间解冻两次，微波炉会显示 dEF2。
2. 转动旋钮 \odot 以选择解冻时间。最长时间为 95 分钟。
3. 按下 Δ_{30} 启动/+30 秒以启动解冻。

所设解冻时间过半后，产品会提示您翻转食物。打开门并翻转食物，然后关上门并按下 Δ_{30} 启动/+30 秒以继续解冻。

厨房定时器

1. 按下 KITCHEN 厨房定时器/时钟一次，屏幕会显示 00:00，时钟指示灯也会亮起。
2. 转动旋钮 \odot 以输入正确的时间。（最长设置时间为 95 分钟。）
3. 按下 Δ_{30} 启动/+30 秒以确认设置，此时时钟指示灯也会闪烁。

所设厨房时间到时后，时钟指示灯将熄灭，蜂鸣器也会响 5 声。

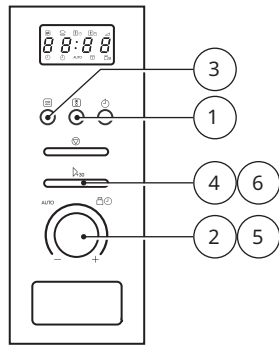

您可以设置本产品以进行多阶段烹煮，以便先解冻，然后再加热：

多阶段加热

1. 连接 按重量/时间解冻两次，微波炉会显示 **dEF2**。
2. 转动旋钮 以选择解冻时间。
3. 按下 **微波** 一次，屏幕会显示 **80**；多次按下此按钮或转动旋钮，则可设置所需的微波火力。
4. 按下 **启动/+30 秒** 以确认火力设置。
5. 转动旋钮 以选择加热时间。
6. 按下 **启动/+30 秒** 以启动加热。

所设解冻时间过半后，产品会提示您翻转食物。

打开门并翻转食物，然后关上门并按下 **启动/+30 秒** 以继续解冻。此时，蜂鸣器将再响一声以进入第二阶段加热。烹煮完成后，蜂鸣器会响五声。

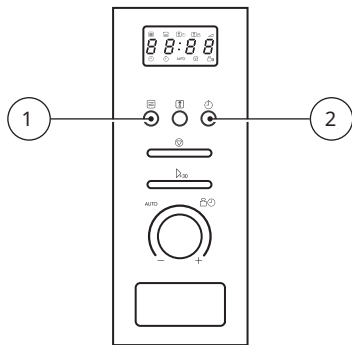

查询功能

1. 在微波加热状态下，按下 **微波**，会显示当前功率 3 秒钟。
2. 在加热状态下，按下 **厨房定时器/时钟** 可查询当天时间，时间会显示 3 秒钟。

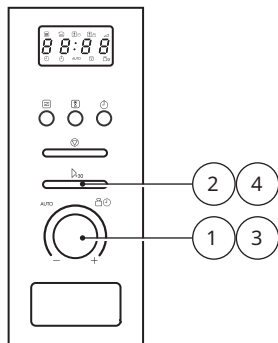

自动菜单

1. 向左转动旋钮 以选择菜单，将显示 **A-1** 到 **A-8**。
2. 按下 **启动/+30 秒** 以确认选定的食物。
3. 转动旋钮 以将默认重量选作菜单图表。
4. 按下 **启动/+30 秒** 以启动加热。

菜单	重量	显示
A-1 比萨饼	200g	200
	400g	400
A-2 肉类	250g	250
	350g	350
	450g	450
A-3 蔬菜	200g	200
	300g	300
	400g	400
A-4 意大利面	50g (带 450g 冷水)	50
	100g (带 800g 冷水)	100
A-5 土豆	200g	200
	400g	400
	600g	600
A-6 鱼类	250g	250
	350g	350
	450g	450
A-7 饮料	1 杯 (120 ml)	1
	2 杯 (240 ml)	2
	3 杯 (360 ml)	3
A-8 爆米花	50g	50
	100g	100

注意：此外，还可在舱门内的标签上查看“食物分类”。

故障排除

正常

微波炉干扰电视接收	微波炉运行时可能会干扰收音机和电视接收。它类似于小型电器所产生的干扰，如搅拌器、吸尘器、电风扇。这属于正常现象。
微波炉灯昏暗	在低火力微波加热状态下，微波炉灯可能会变暗。这属于正常现象。
蒸汽积聚在舱门上，热空气从通风口排出。	加热时，食物可能会产生蒸汽。多数蒸汽均可从通风口排除，但部分蒸汽也可能在舱门等低温区域积聚。这属于正常现象。
微波炉在未放入食物的情况下意外启动。	严禁在未放入任何食物的情况下运行设备。 此举十分危险。

故障	潜在原因	解决办法
微波炉无法启动。	(1) 电源线未插紧。	拔出电源插头。 等待 10 秒钟，然后再次插入插头。
	(2) 保险丝熔断或断路器跳闸。	更换保险丝或复位断路器（由我公司专业人员进行维修）。
	(3) 电源插座出现故障。	用其他电气设备测试电源插座。
微波炉无法加热	(4) 舱门未关紧。	重新关好舱门。

规格

型号:	LAGAN 706.094.95
额定电压:	220V~50Hz
额定输入功率 (微波):	1250 W
额定输出功率 (微波):	800 W
微波炉容量:	20 L
转盘直径:	Ø 245 mm
外部尺寸:	595 × 344 × 394 mm
净重:	15 kg
噪音:	≤ 63dB (A)

序列号 (以 SN 开头的 22 位代码)

序列号: xxxxxxxxxxxxxxxxxxxxxxxxx

产品编号 (8 位代码)

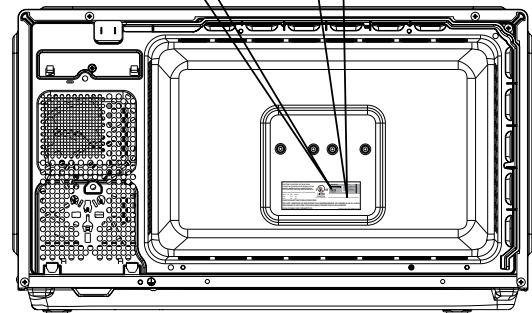

图片仅供参考

安装和连接

1. 本电器仅供家庭使用。
2. 本产品仅供嵌入式使用。它不适于柜台使用或在橱柜内使用。
3. 请遵守特殊安装说明。
4. 本设备可安装在 60 厘米宽的壁挂式橱柜中。
5. 本设备配有插头，且须连接到正确安装并接地的插座上。
6. 电源电压必须与铭牌上指定的电压相匹配。
7. 无论是安装插座还是更换连接电缆，均须由合格的电工完成。如果在安装后无法再触及插头，则须在安装侧安装全极断开装置，且接触间隙至少需达到 3 毫米。
8. 不得使用适配器、多路带和延长线。超载可能会引发火灾。
9. 本产品的安装高度不应低于 85 厘米。



操作期间，可接触表面可能会变热。

环保要求



根据电子电气设备废弃物 (WEEE) 指令，电子电气设备废弃物应单独进行收集和处理。未来若需处理本产品，请勿将其与生活垃圾一同处理。请将本产品送往电子电气设备废弃物收集点 (如果有)。

宜家质保

服务指引

● 宜家产品的质保期有多长？

自原始购买之日起，宜家电器享有五 (5) 年质保服务。需提供原始销售收据作为购买凭证。如果质保期内出现售后服务，售后服务不会延长产品的质保期限。

● 哪些 LAGAN 电器不享受宜家的 5 年质保？

对于 2026 年 5 月 1 日之前从宜家购买的 LAGAN 电器，自原始购买之日起，质保期为两 (2) 年。

● 由谁提供售后服务？

宜家将通过自己的售后服务中心或者经授权的第三方提供售后服务。

● 产品质保涵盖哪些内容？

质保涵盖从宜家购买日期算起，由制造问题或不良材料导致的设备故障。本质保仅对家用生效。"产品质保不涵盖哪些内容？" 标题中规定了例外条件。质保期内的维修成本，例如修理、配件、人工和差旅费无需用户承担，前提是维修设备时不产生特别支出。更换下来的部件将归宜家所有。

● 宜家将如何纠正问题？

宜家会对产品进行检查，并单独裁定产品是否享受质保。如果产品享受质保，宜家或指定的售后服务方会单独裁定是否维修缺陷产品，还是替换为相同或同等产品。

● 产品质保不涵盖哪些内容？

正常磨损。

故意或疏忽造成的损坏；不遵守操作说明、不正确安装或连接错误电压造成的损坏；化学或电化学反应、生锈、腐蚀造成的损坏；或者水造成的损坏，包括但不限于水中过量石灰造成的损坏；以及异常环境条件造成的损坏。

易损件，包括电池和灯。

不影响设备正常使用的非功能和装饰性部件，包括各种划痕和色差。

外物以及清洗或疏通过滤器、排水系统或肥皂盒导致的意外损坏。

以下部件受损：陶瓷玻璃、附件、餐具篮、进水和排水管、密封件、灯和灯盖、屏幕、旋钮、外壳和外壳部件。除非能证明受损是由生产故障所导致。

维修人员未能发现故障问题。

维修工作不是由我们的指定服务提供商和/或授权服务合作伙伴执行，或者未使用原厂配件。

因错误安装或未按照规范安装而导致的维修。

设备未在家用环境中使用，即用于专业用途。

运输过程中损坏。如果客户将产品运送到自己家或另一地址，宜家对运输中产生的任何损坏不负责。

如果宜家负责将产品运到客户指定送货地址，那么运输途中发生的产品损坏由宜家承担。

宜家设备的初装费用。如果宜家指定服务提供商或其授权服务合作伙伴依照保修条款维修或更换设备，如有必要，指定服务提供商或其授权服务合作伙伴应重新安装修复后的设备或安装替换。

● 如何遵守当地法律？

宜家质保政策为您提供的合法权益符合或超过所有当地法律要求。这些条件不会以任何方式限制当地法。

● 有效区域。

此宜家保障仅适用于在中国购买并安装使用的产品。

只有设备符合以下条件并按照以下条件进行安装，宜家才有义务依照保障框架提供维修服务：

- 提出保障申请时所在国家的技术规格；
- 《安装说明》和《用户手册安全信息》。

● 宜家产品售后。

请及时联系宜家指定售后服务方，以便：

提出保障服务申请；

要求宜家对其电器产品安装于宜家厨房家具进行解答；

要求宜家对其产品功能进行解答；

为确保我们为您提供最佳协助，联系我们之前请仔细阅读《安装说明》和/或《用户手册》。

服务热线：400-8002-345

热线时间：9:00-21:00

为向您提供更快速的维修服务，请同时提供设备铭牌上注明的宜家产品编号（8位编码）。

●保留销售收据！

收据是您的购买凭证，在申请保修时需要提供收据。销售收据还注明宜家店名以及您所购买的每件设备的编号（8位编码）。

●您是否需要额外的帮助？

如需咨询与产品售后无关的任何其他问题，请联系最近的宜家商店客服中心。我们建议您在联系我们之前仔细阅读设备文档。

中国RoHS

产品中有害物质的名称及含有信息表

部件名称	有害物质									
	铅 (Pb)	汞 (Hg)	镉 (Cd)	六价铬 (Cr(VI))	多溴联苯 (PBBs)	多溴二苯醚 (PBDEs)	邻苯二甲酸二正丁酯 (DBP)	邻苯二甲酸二异丁酯 (DIBP)	邻苯二甲酸丁苄酯 (BBP)	邻苯二甲酸二(2-乙基)己酯 (DEHP)
变频器	×	○	×	○	○	○	○	○	○	○
触摸屏	×	○	○	○	○	○	○	○	○	○
电机组件	×	○	○	○	○	○	○	○	○	○
电脑板	×	○	×	○	○	○	○	○	○	○
电源线	×	○	○	○	○	○	○	○	○	○
定时器	×	○	×	○	○	○	○	○	○	○
风机组件	×	○	○	○	○	○	○	○	○	○
高压变压器	○	○	×	○	○	○	○	○	○	○
高压二极管组件	×	○	○	○	○	○	○	○	○	○
控制面板组件	×	○	○	○	○	○	○	○	○	○
滤波板组件	×	○	×	○	○	○	○	○	○	○
水泵组件	×	○	○	○	○	○	○	○	○	○
温度、湿度传感器	×	○	○	○	○	○	○	○	○	○
温控器	×	○	×	○	○	○	○	○	○	○
扬声器、蜂鸣器	×	○	○	○	○	○	○	○	○	○
蒸汽发生器	×	○	○	○	○	○	○	○	○	○
灶台板组件	×	○	○	○	○	○	○	○	○	○
烤箱阀体、电磁阀、喷嘴	×	○	○	○	○	○	○	○	○	○
烤箱一体化灯	×	○	○	○	○	○	○	○	○	○
烤箱门锁	×	○	○	○	○	○	○	○	○	○
烤箱温度探针	×	○	○	○	○	○	○	○	○	○
烤箱接线盒	×	○	○	○	○	○	○	○	○	○
烤箱转换开关	×	○	×	○	○	○	○	○	○	○
烤箱能量调节器	×	○	○	○	○	○	○	○	○	○

备注:

1. ○:表示该有害物质在该部件所有均质材料中的含量均不超出电器电子产品有害物质限制使用国家标准要求。
2. ×:表示该有害物质至少在该部件的某一均质材料中的含量超出电器电子产品有害物质限制使用国家标准要求。
3. 以上未列出的部件,表明其有害物质含量均不超出电器电子产品有害物质限制使用国家标准要求。
4. 以上清单中所包含零部件依据不同产品型号略有不同。
5. 本产品在正常使用情况下,环保使用期限为15年,建议使用一定年限后更换新机。

微波炉食品接触材料信息

请根据说明书要求正常使用本产品。

本产品食品接触用材料及部件符合GB 4806.1-2016 GB 9685-2016以及相应材料食品安全国家标准要求，具体信息如下：

材质	用途	执行标准	备注
ABS	水盒组件（水盒）	GB 4806.7-2023	仅接触水，使用温度20°C-60°C
POM	水盒组件(水管塞)	GB 4806.7-2023	仅接触水，使用温度20°C-60°C
PP	波导盖、水盒组件（导水管）	GB 4806.7-2023	导水管仅接触水，使用温度20°C-60°C
PET	门贴	GB 4806.7-2023	----
铝合金YZAISi11Cu3	蒸气发生器组件	GB 4806.9-2023	仅接触水，使用温度20°C-160°C
云母	波导盖	GB 4806.4-2016	使用温度110°C
不锈钢10Cr17	门体、内胆、发热管罩	GB 4806.9-2023	----
电镀锌钢板基材/ 环氧聚酯涂层	门体、内胆基材，涂层	GB 4806.9-2023 GB 4806.10-2016	----
冷轧钢板基材/ 环氧聚酯涂层	门体、内胆基材，涂层	GB 4806.9-2023 GB 4806.10-2016	----
热镀锌钢板基材/ 环氧聚酯涂层	门体、内胆基材，涂层	GB 4806.9-2023 GB 4806.10-2016	----
热镀锌钢板基材/ 高温有机硅涂层	门体、内胆基材，涂层	GB 4806.9-2023 GB 4806.10-2016	----
不锈钢10Cr17基材/ 高温有机硅涂层	门体、内胆基材，涂层	GB 4806.9-2023 GB 4806.10-2016	----
不锈钢06Cr19Ni10 基材/高温有机硅涂层	门体、内胆基材，涂层	GB 4806.9-2023 GB 4806.10-2016	----
搪瓷钢板基材/ 搪瓷涂层	内胆、烤盘基材，涂层	GB 4806.9-2023 GB 4806.3-2016	烤盘为可选配件，使用温度100°C-300°C
钢丝基材/镀铬/ 镍/铜镀层	烤架基材，涂层	GB 4806.9-2023	可选配件，不得接触酸性食品，使用温度100°C-300°C
玻璃	玻璃盘、烤盘、烧烤管	GB 4806.5-2016	使用温度100°C-300°C
硼硅玻璃或微晶 陶瓷	内隔板	GB 4806.5-2016 GB 4806.4-2016	使用温度40°C-300°C
陶瓷	蒸气发生器组件（盖）	GB 4806.4-2016	仅接触水，使用温度100°C-300°C
硅胶	蒸气发生器组件（水管）、进水管、出水管、密封圈、门体滴胶	GB 4806.11-2016	使用温度20°C-230°C
不锈钢06Cr19Ni10	水盒组件（弹簧）、金属发热管、温度传感器探头、水泵、烤架	GB 4806.9-2023	烤架使用温度100°C-300°C

微波炉食品接触材料信息

请根据说明书要求正常使用本产品。

本产品食品接触用材料及部件符合GB 4806.1-2016 GB 9685-2016以及相应材料食品安全国家标准要求，具体信息如下：

材质	用途	执行标准	备注
PBT	水箱镶件	GB 4806.7-2023	仅接触水，使用温度20°C-100°C
PPS	蒸汽发生器盖、蒸盘支架	GB 4806.7-2023	仅接触水，使用温度20°C-120°C
LCP E130i	塑料三通管	GB 4806.7-2023	使用温度20°C-230°C
50%ABS+50%PC	水箱座	GB 4806.7-2023	仅接触水，使用温度20°C-100°C
PP+RS9120	浮球	GB 4806.7-2023	导水管仅接触水，使用温度20°C-60°C
PTFE	蒸架	GB 4806.7-2023	使用温度230°C

备注：

- 1 所列部品为可能接触食物部品，不宜作为容器长期存储食品；
- 2 本系列产品包含以上食品接触材料及部件，但部分机型可能不含个别材料及部件，以实际产品为准。

